

FAG

## 3309-BD-XL-TVH-C3

Angular contact ball bearing

Schaeffler ID:  
0631871750030

Angular contact ball bearing 33..-BD-XL-TVH, double row, X-life, plastic cage



X-life

## Technical information

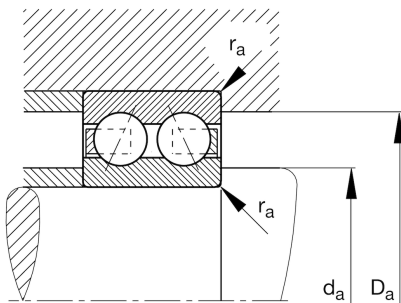
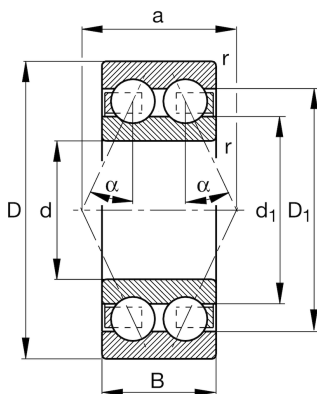

## Main Dimensions &amp; Performance Data

d	45 mm	Bore diameter
D	100 mm	Outside diameter
B	39.7 mm	Width
$C_r$	72,000 N	Basic dynamic load rating, radial
$C_{0r}$	54,000 N	Basic static load rating, radial
$C_{ur}$	3,700 N	Fatigue load limit, radial
$n_G$	7,300 1/min	Limiting speed
$n_{gr}$	6,700 1/min	Reference speed
	1.31 kg	Weight

## Mounting dimensions

$d_{a \min}$	54 mm	Minimum diameter shaft shoulder
$D_{a \max}$	91 mm	Maximum diameter of housing shoulder
$r_{a \max}$	1.5 mm	Maximum fillet radius

## Dimensions

$r_{\min}$	1.5 mm	Minimum chamfer dimension
$D_1$	84.4 mm	Shoulder diameter outer ring
$d_1$	65.5 mm	Shoulder diameter inner ring
a	57.8 mm	Distance between the apexes of the pressure cones
$\alpha$	30 °	Contact angle

## Temperature range

$T_{\min}$	-30 °C	Operating temperature min.
$T_{\max}$	120 °C	Operating temperature max.